









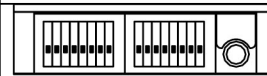

Multi - Station

2 Bay / Desk Options

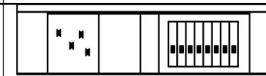
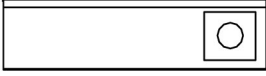
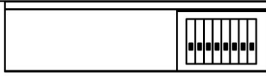
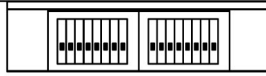
Flat Surface	1 Mix	2 Mix	1 Mix - 1 Transport	2 Mix - 1 Transport	Control	Control - 1 Mix
	 A1	 B1	 C1	 D1	 E1	 F1
Cranesong Avocet  Call Dangerous SR Remote	 A2	 B2	 C2	 D2	 E2	 F2
 Call		 B3	 C3		 E3	 F3
Transport	Control - Transport	Control-Mix-Transport				
 G1	 H1	 I1				
 G2	 H2	 I2				
	 H3					

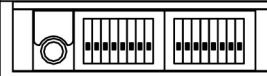
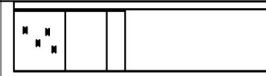
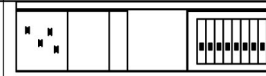
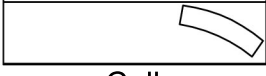
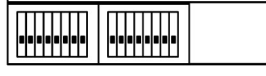
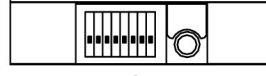
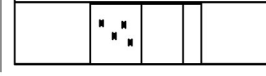
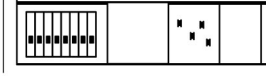
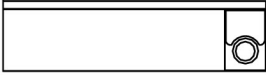
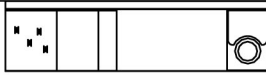
Multi - Station

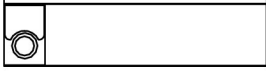
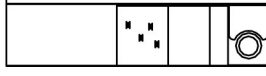
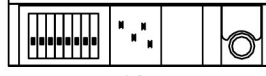
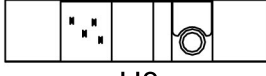
3 Bay - Desk Options

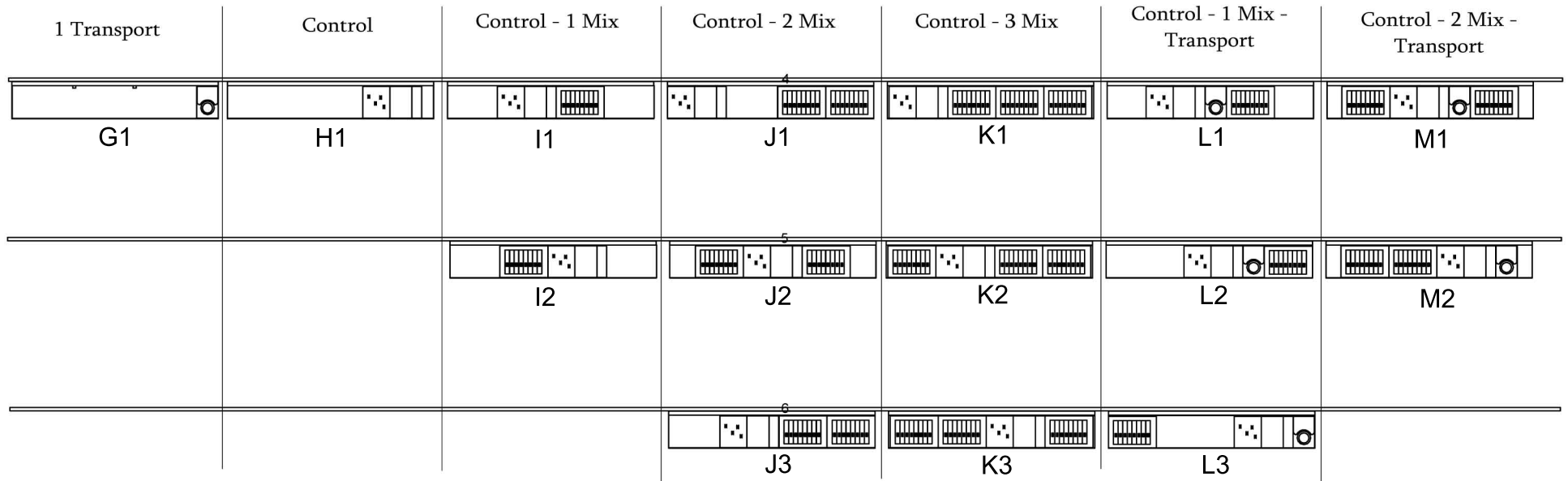
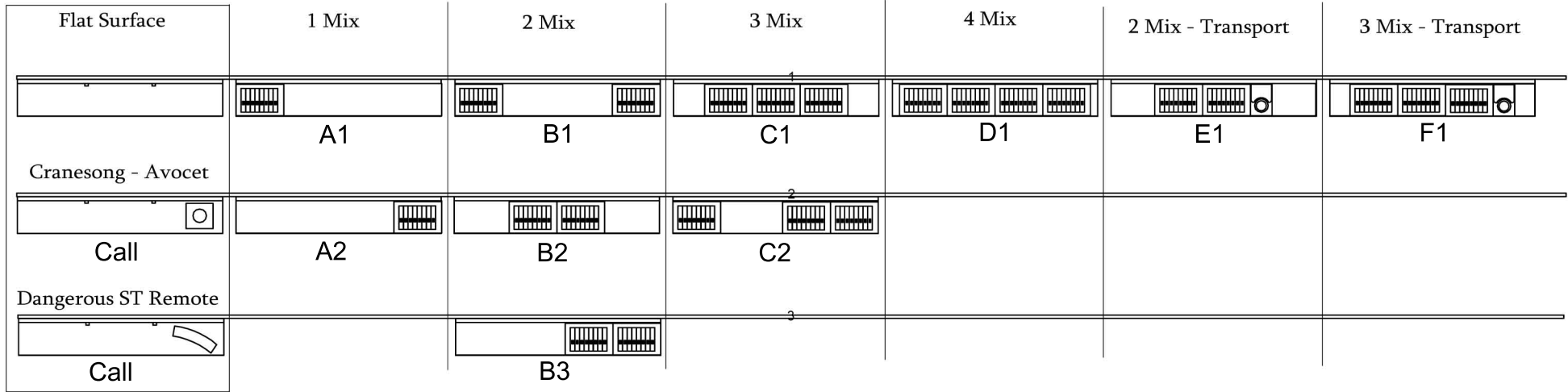

The Multi - Station

2 Bay Footprint & Dimensions

from Sterling Modular

Avid Artist Series

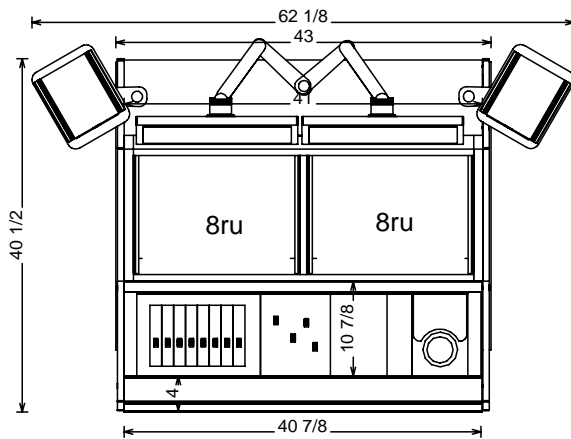

Shown with optional speaker platforms and LCD arms

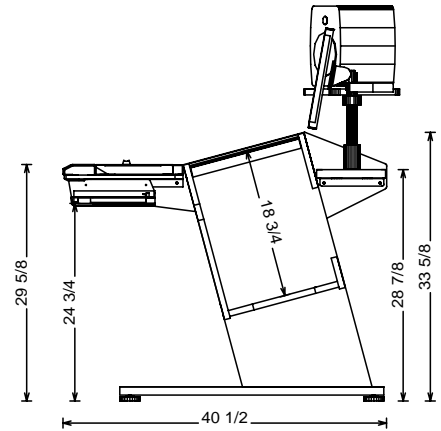

Edit / Mix / Master

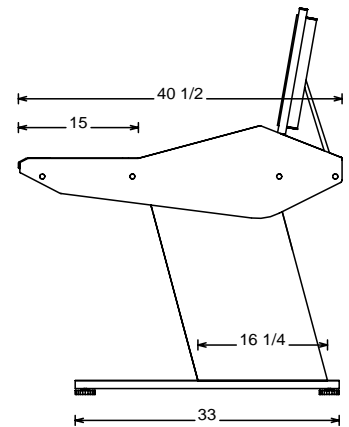
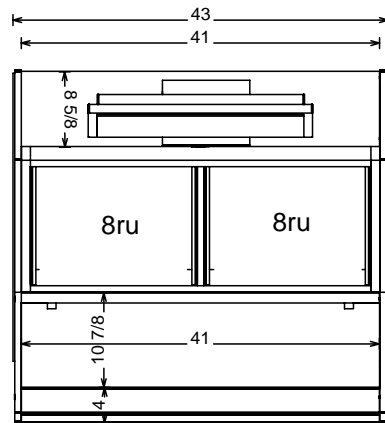

Compose / Record

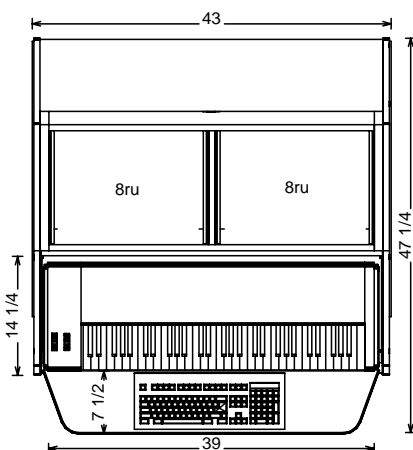

Workstation (large keyboards)

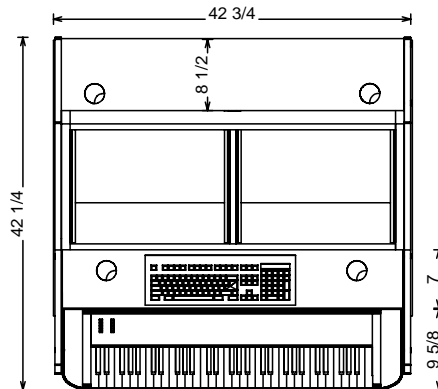

Controller (small keyboards)

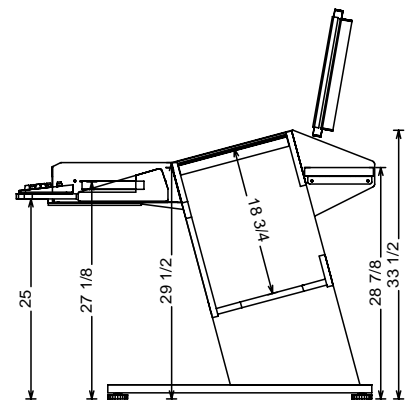

Choose your weapon